

Nest

SPACE WITHIN SPACE

Design Petteri Häkkinen & ISKU Team

Nest is a fun space that offers acoustic protection for studying or working. This cabin-like solution works as a space divider where you can hide for a while in your own peace.

Frame of the Nest is made of plywood. Fireproof foam acts as an acoustic element. The sides, background and roof can be selected in different colors. Nest is available with one or two sofas or just as it is without any soft seating. The sofas can be equipped with a socket. Adjustable legs.

Materials and finishing

Frame ISKU standard Fabric collection
Sofas ISKU standard Fabric collection

Dimensions

Width 184cm
Depth 100cm
Height 204cm front, 189cm back



Nest

SPACE IN A SPACE

Datasheet

The frame of the Nest is made of plywood and upholstered with fireproof foam and selected fabrics. The sides, background and roof can be selected in different colors. The color of the roof is the same as the color of the selected sofas. Nest hole in the backwall is selectable.

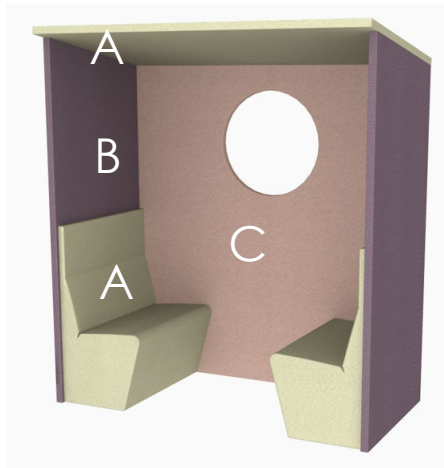

A Roof & sofa
B Sides
C Background

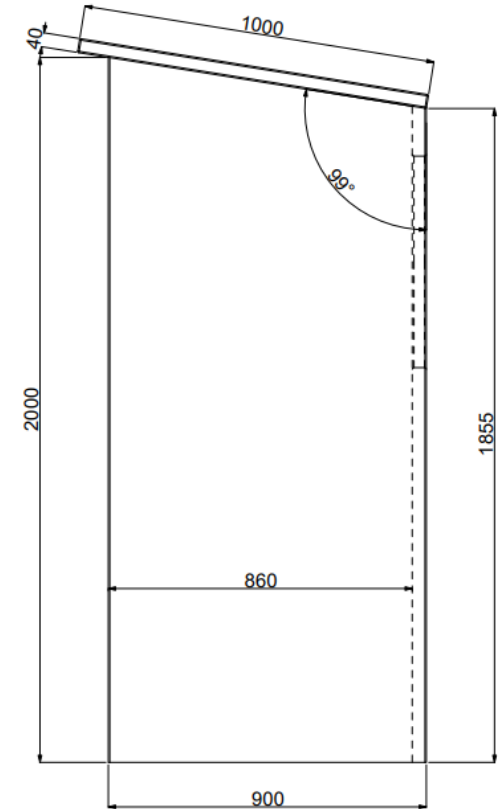
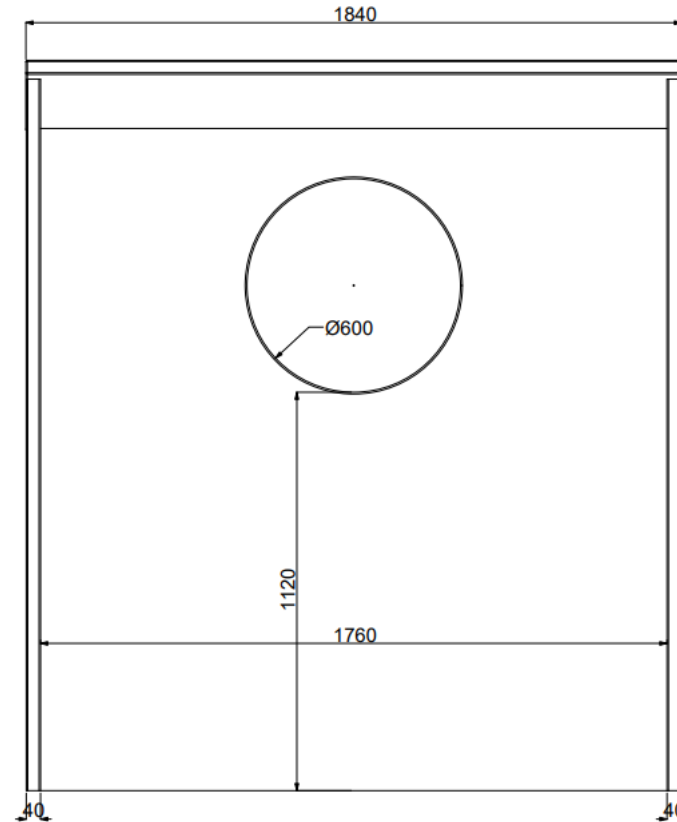

Nest

SPACE IN A SPACE

Datasheet

Nest is available in three configurations: with two sofas facing each other (sofa 850), with a single sofa against Nest's back wall (sofa 1750), or as a standalone unit. Sofas can be equipped with electrical sockets (schuko).

ISKU
Since 1928

SOFA 850

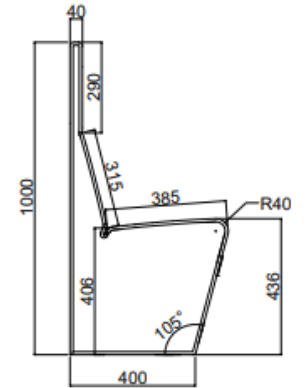
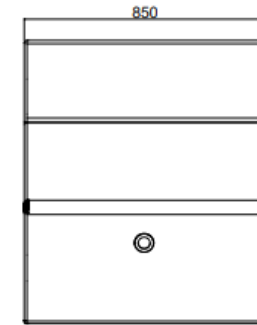
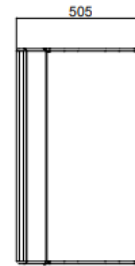
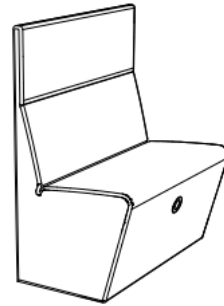
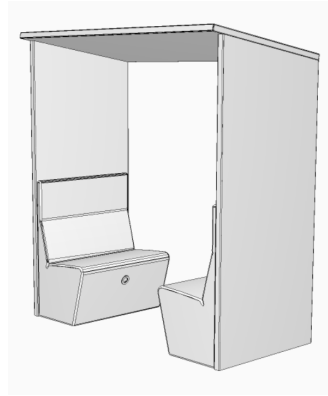

WITHOUT SOFAS

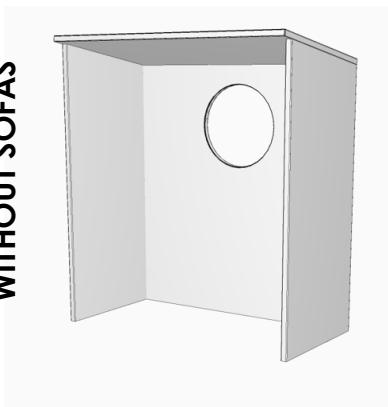

SOFA 1750

