

Tutto

CHAIR FAMILY WITH WIDE VARIETY

Design Mikko Laakkonen

Tutto is a beautiful and diverse family of chairs that grows and serves the wide variety of interior design needs. The Tutto chair and its designer Mikko Laakkonen received an Honorary Award in Suomi100 Design Competition operationalized by ISKU.



ISKU
Since 1928

Tutto

CHAIR FAMILY



Models, Materials and Functions

Seat and backrest materials

Available in formed wood (birch, beech, oak, ash), technical veneers (natural birch, plywood color, deadwood grey) and laminates (white, birch, beech, dark grey, oak, light grey and black).

The seat is also available as painted in white or black. The seat and backrest can be upholstered with ISKU standard fabrics with some exceptions.

4 backrest options

Solid back (low or high)
Two-part back (low or high).
The color of the screw in two-part backrest is gray, silver, black or white.

Leg options

Tubular 4-leg frame of powder-coated steel (ISKU Standard colours) or chrome.

Loop leg frame of powder coated steel (ISKU standard colours) or chrome.

Wooden legs (beech, birch, oak, ash)

Cross-bases (with pads or castors)

Armrests

Most models are available with armrests, specified on the product card of the chair model.

Stackability

The chair with metal frame are stackable. In the chair trolley stackability of Tutto with solid back is 20 pcs, and with two-part back 15 pcs. On the floor the stackability is 15 pcs.

Linking

Loop-legged and tubular 4-legged chairs can be connected together in rows by a secure linking device.





Tutto

ISKU
Since 1928

Tutto

CHAIR WITH TUBULAR 4-LEG FRAME

Design Mikko Laakkonen

Tutto is a beautiful and diverse family of chairs that grows and serves the wide variety of interior design needs. The tubular 4-leg chair is stackable and light option for the public spaces.

The Tutto chair and the its designer Mikko Laakkonen received an Honorary Award in Suomi100 Design Competition operationalized by ISKU.

Materials and finishing

Frame of the 4-leg chair is powder-coated steel (ISKU standard colours) or chrome. The chair is available with armrests.

Seat and backrest options and materials are described in the *Models, Materials and Functions Datasheet*.

Dimensions

Width	560/580 mm
Depth	540/560/580 mm
Height	800/900 mm
Seating height	450 mm

The dimensions are specified as per the models on the following datasheet.

Video



Tutto

CHAIR WITH TUBULAR 4-LEG FRAME

Dimensions

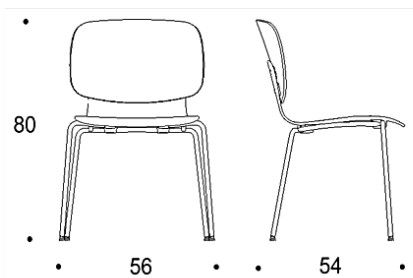

Two-part low back

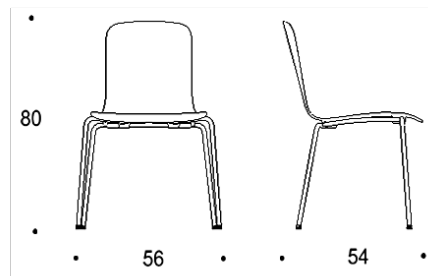

Solid low back

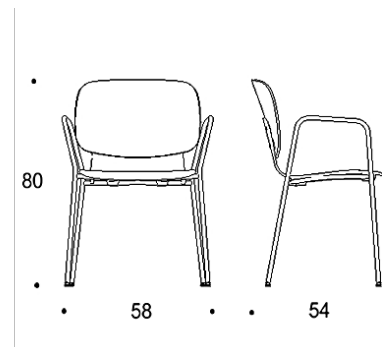

Two-part low back, armrests

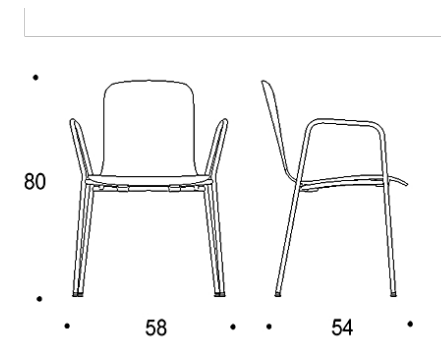

Solid low back, armrests

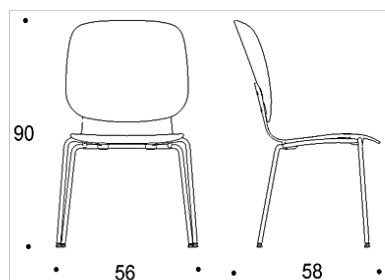

Two-part high back

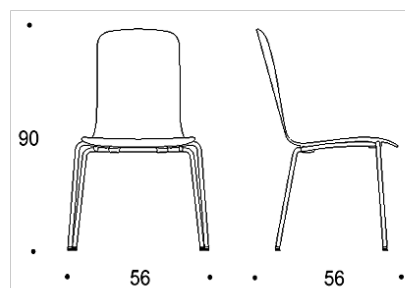

Solid high back

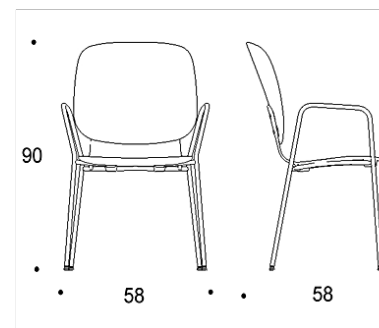

Two-part high back, armrests

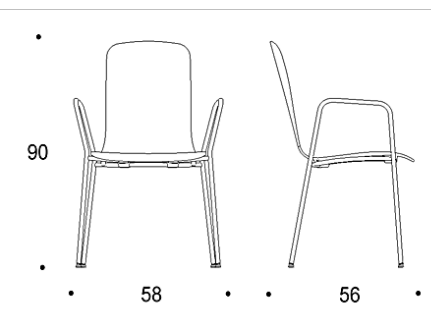

Solid high back, armrests

Chairs can be connected in rows by a secure linking device.

Tutto

CHAIR WITH LOOP LEG

Design Mikko Laakkonen

Tutto is a beautiful and diverse family of chairs that grows and serves the wide variety of interior design needs. The loop leg chair is stackable. It's ideal for the spaces where the chairs are used in rows, as the chairs link to each other easily.

The Tutto chair and the its designer Mikko Laakkonen received an Honorary Award in Suomi100 Design Competition operationalized by ISKU.

Materials and finishing

Loop leg frame is powder-coated steel (ISKU standard colours) or chrome. The chair is available with the armrests allowing the chair to be hung up. Seat and backrest options and materials are described in the *Models, Materials and Functions Datasheet*.

Dimensions

Width	560/580 mm
Depth	540/560/580 mm
Height	800/900 mm
Seating height	450 mm

Video



SCAN ME

The dimensions are specified as per the models on the following datasheet.



Tutto

CHAIR WITH LOOP LEG

Dimensions

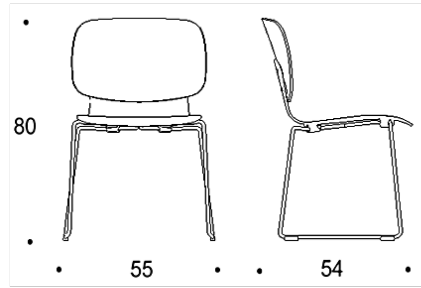

Two-part low back

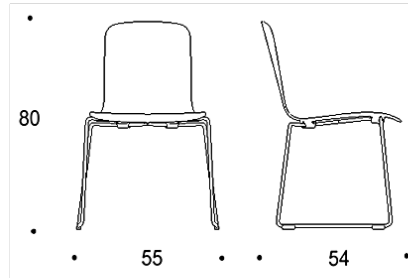

Two-part low back

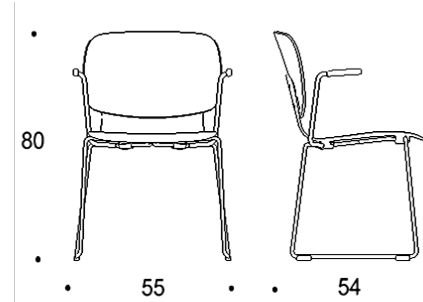

Two-part low back, armrests

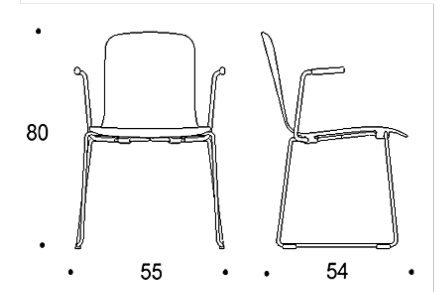

Solid low back, armrests

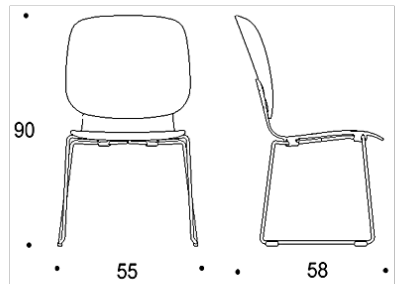

Two-part high back

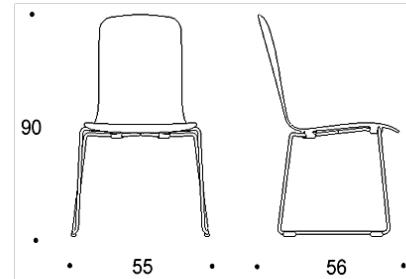

Solid high back

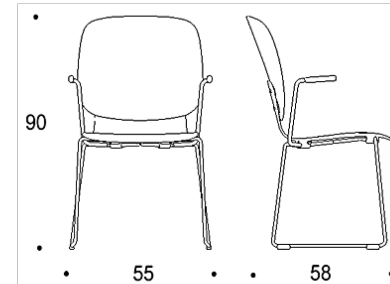

Two-part high back, armrests

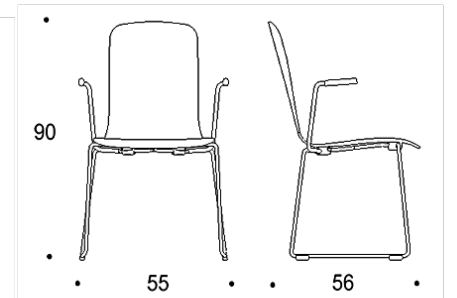

Solid high back, armrests

Chairs can be connected in rows by a secure linking device.



Tutto

ISKU
Since 1928

Tutto

CHAIR WITH HEIGHTENED SEAT

Design Mikko Laakkonen

Tutto is a beautiful and diverse family of chairs that grows and serves the wide variety of interior design needs. The chair with wooden legs is a representative of Nordic design and brings soft look to any space.

The Tutto chair and the its designer Mikko Laakkonen received an Honorary Award in Suomi100 Design Competition operationalized by ISKU.

Materials and finishing

The frame of the 4-leg heightened chair is powder-coated steel (ISKU standard colours) or chrome. The chair is equipped with armrests.

Seat and backrest options and materials are described in the *Models, Materials and Functions Datasheet*.

Dimensions

Width	580 mm
Depth	540/560/580 mm
Height	870/950/980 mm
Seating height	520 mm

Video



The dimensions are specified as per the models on the following datasheet.



Tutto

CHAIR WITH HEIGHTENED SEAT

Dimensions

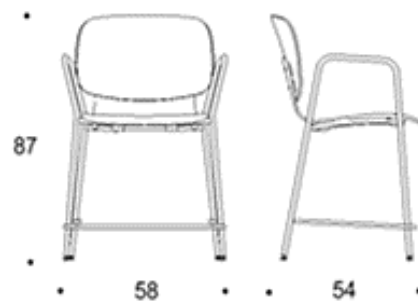

Two-part low back

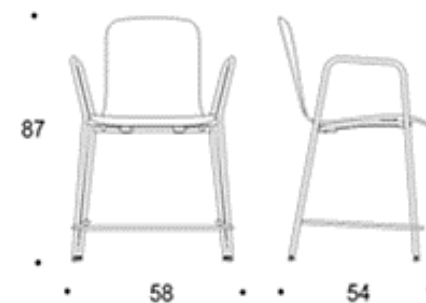

Solid low back

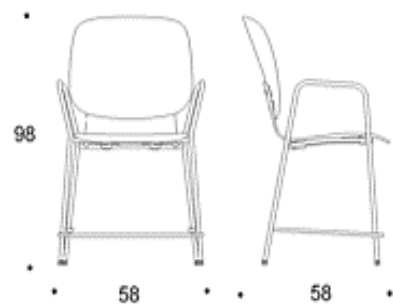

Two-part high back

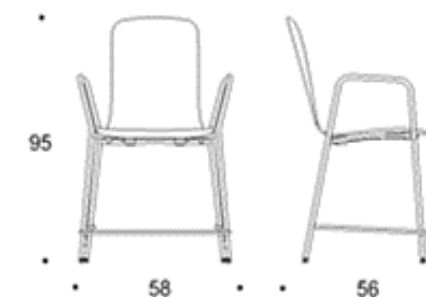

Solid high back



Tutto

ISKU
Since 1928

Tutto

BAR STOOL, METAL LEGS

Design Mikko Laakkonen

Tutto is a versatile and elegant family of chairs designed to meet the diverse needs of modern interior design. Its lightweight design makes it perfect for spaces where you want seating that doesn't compromise on an airy, open look. The bar stool is stackable, adding to its functionality and space-saving appeal.

The Tutto chair collection received an Honorary Award in the Suomi100 Design Competition.

Materials and finishing

Leg frame is powder-coated steel (ISKU standard colours) or chrome.

Seat and backrest options and materials are described in the *Models, Materials and Functions Datasheet*.

Dimensions

	LOW	HIGH
Width	570 mm	590 mm
Depth	520 mm	530 mm
Height	850 mm	950 mm
Seating height	650 mm	750 mm

Video



Tutto

BAR STOOL, WOODEN LEGS

Design Mikko Laakkonen

Tutto is a beautiful and diverse family of chairs designed to meet a wide variety of interior design needs. The bar stool with wooden legs exemplifies Nordic design, bringing a soft and inviting look to any space.

The Tutto chair, along with its designer Mikko Laakkonen, received an Honorary Award in the Suomi100 Design Competition, organized by ISKU.

Materials and finishing

Legs are solid wood (birch, oak or ash). Legs are available with ISKU standard stained colours. The foot ring is powder-coated steel (ISKU standard colours).

Seat and backrest options and materials are described in the *Models, Materials and Functions Datasheet*.

Dimensions

Width	460 mm
Depth	520 mm
Height	850 mm
Seating height	650 mm

Video



Tutto

BARSTOOLS

Dimensions

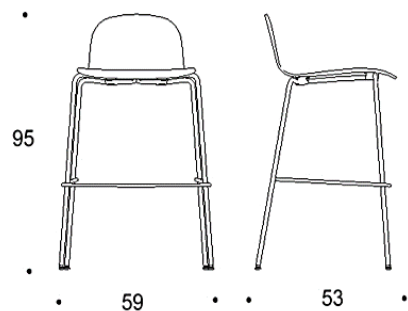

Metal leg
seating height 75cm

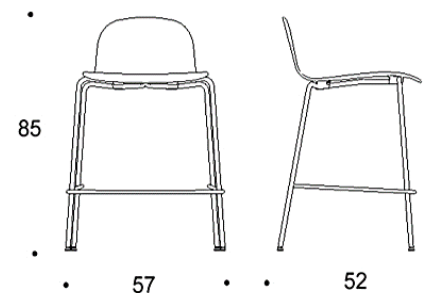

Metal leg
Seating height 65cm

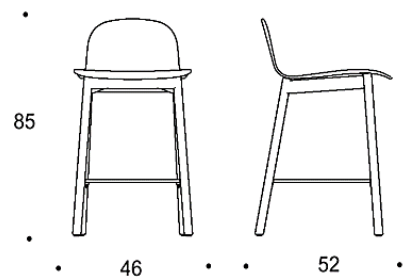

Wooden leg
Seating height 65cm



Tutto

ISKU
Since 1928

Tutto

CHAIR WITH WOODEN LEGS

Design Mikko Laakkonen

Tutto is a beautiful and diverse family of chairs that grows and serves the wide variety of interior design needs. The chair with wooden legs is a representative of Nordic design, and brings soft look to any space.

The Tutto chair and the its designer Mikko Laakkonen received an Honorary Award in Suomi100 Design Competition operationalized by ISKU.

Materials and finishing

Legs are solid wood (birch, beech, oak or ash). Legs are available with ISKU standard stained colours.

Seat and backrest options and materials are described in the *Models, Materials and Functions Datasheet*.

Dimensions

Width	450/490 mm
Depth	540/560/580 mm
Height	800/900 mm
Seating height	450 mm

The dimensions are specified as per the models on the following datasheet.

Video



Tutto

CHAIR WITH WOODEN LEGS

Dimensions

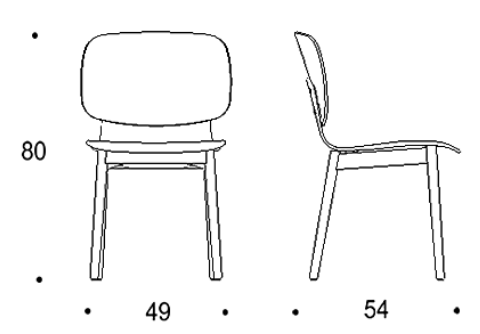

Solid high back, armrests

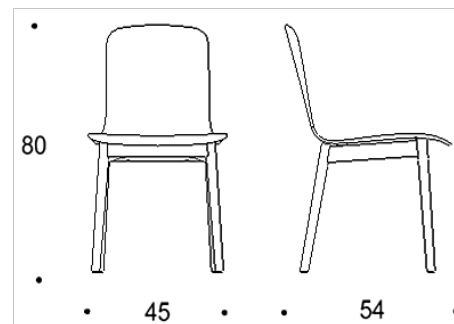

Solid low back

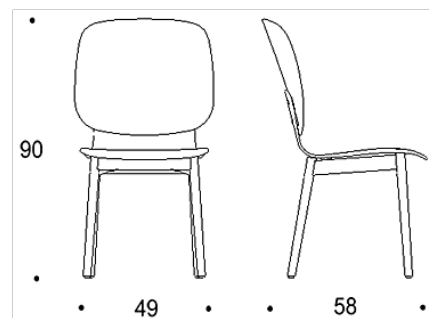

Two-part high back

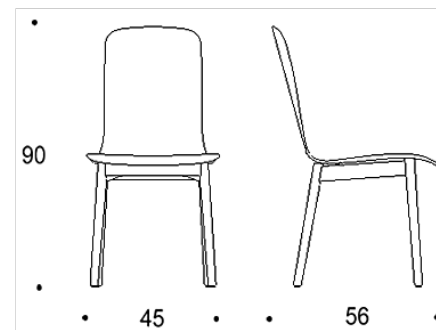

Solid high back



Tutto

ISKU
Since 1928

Tutto

CHAIR WITH 4-LEG CROSS-BASE

Design Mikko Laakkonen

Tutto is a beautiful and diverse family of chairs that grows and serves the wide variety of interior design needs. The chair with 4-leg modern cross-base is a nice and light option for to the meeting rooms and other shared spaces.

The Tutto chair and the its designer Mikko Laakkonen received an Honorary Award in Suomi100 Design Competition operationalized by ISKU.

Materials and finishing

The cross-base is powder-coated steel (black, white) or chrome. Available with armrests.

Seat and backrest options and materials are described in the *Models, Materials and Functions Datasheet*.

Dimensions

Width	500 mm / 590 mm
Depth	530 mm / 550 mm / 560 mm
Height	790 mm / 870 mm /890mm
Seating height	440 mm

The dimensions are specified as per the models on the following datasheet.



Tutto

CHAIR WITH 4-LEG CROSS-BASE

Dimensions

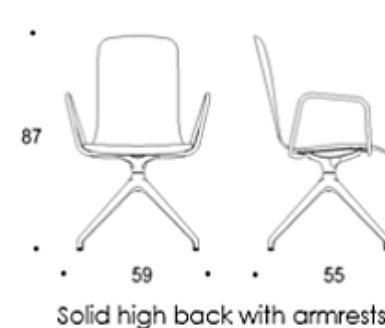
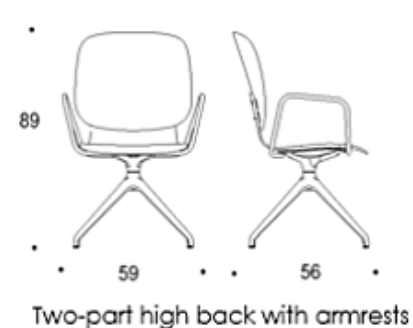
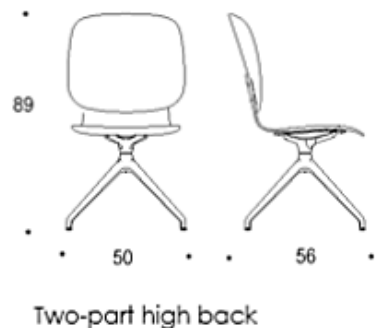
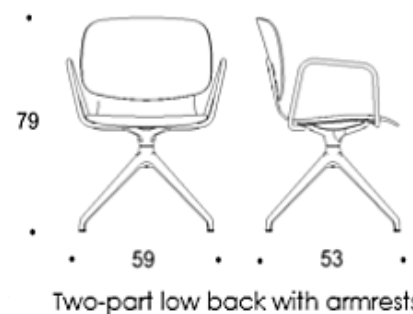
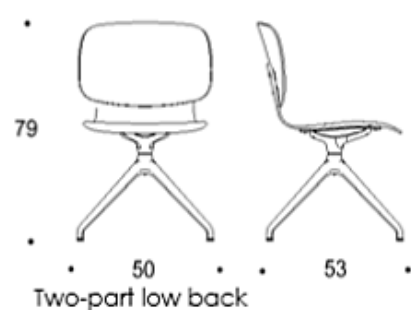

Tutto

CHAIR WITH 4-LEG CROSS-BASE AND CASTORS

Design Mikko Laakkonen

Tutto is a beautiful and diverse family of chairs that grows and serves the wide variety of interior design needs. Tutto chair with castors is a nice and light option for working chair or to the meeting rooms.

The Tutto chair and the its designer Mikko Laakkonen received an Honorary Award in Suomi100 Design Competition operationalized by ISKU.

Materials and finishing

The cross-base is powder-coated steel (black, white or silver). Available with armrests.

Seat and backrest option and materials are described in the *Models, Materials and Functions Datasheet*.

Dimensions

Width	520 mm / 590 mm
Depth	530 mm 560 mm
Height	910 mm / 930 mm
Seating height	470 mm

The dimensions are specified as per the models on the following datasheet.



Tutto

CHAIR WITH 4-LEG CROSS-BASE AND CASTORS

Dimensions

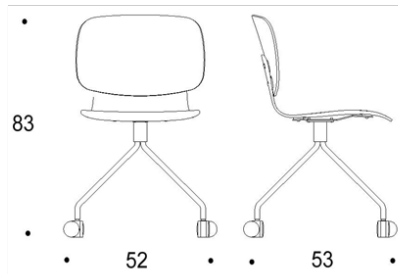

Two-part low back

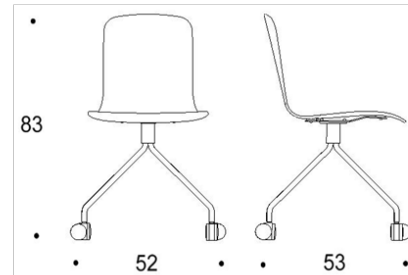

Solid low back

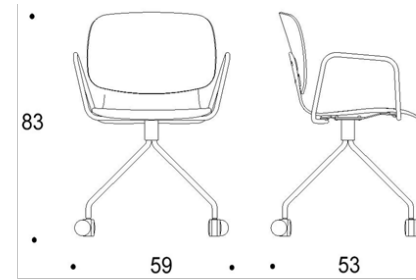

Two-part low back with armrests

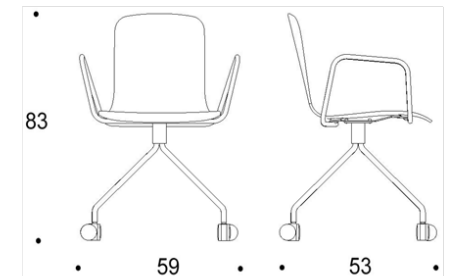

Solid low back with armrest

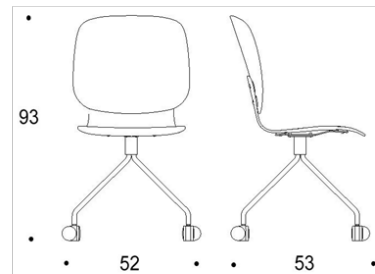

Two-part high back

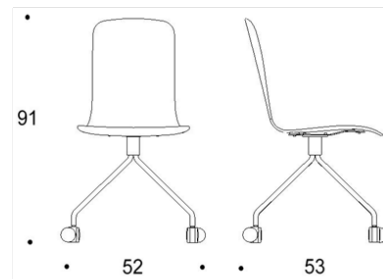

Solid high back

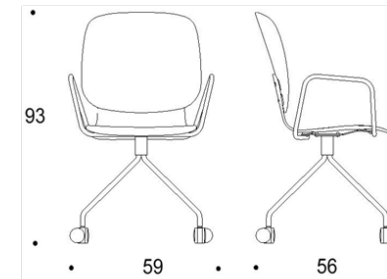

Two-part high back

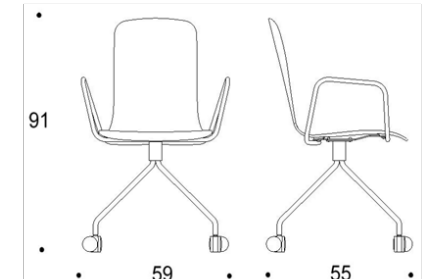

Solid high back with armrests

Tutto

HEIGHT-ADJUSTABLE CHAIR WITH CROSS-BASE AND CASTORS

Design Mikko Laakkonen

Tutto is a beautiful and diverse family of chairs that grows and serves the wide variety of interior design needs. The chair with castors is a nice and light option for working chair or to the meeting rooms.

The Tutto chair and the its designer Mikko Laakkonen received an Honorary Award in Suomi100 Design Competition operationalized by ISKU.

Materials and finishing

Powder-coated steel (black, white) or polished aluminum (chrome colour). Available with armrests or without.

Seat and backrest option and materials are described in the *Models, Materials and Functions Datasheet*.

Dimensions

Width	610 mm
Depth	610 mm
Height	790 – 990 mm (low back), 890 – 1000 mm (high back)
Seating height	440 – 550 mm

The dimensions are specified as per the models on the following datasheet.



Tutto

HEIGHT-ADJUSTABLE CHAIR WITH CROSS-BASE AND CASTORS

Dimensions

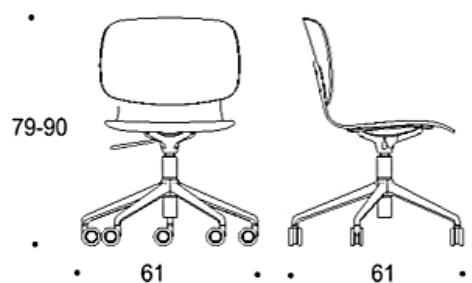

Two-part low back

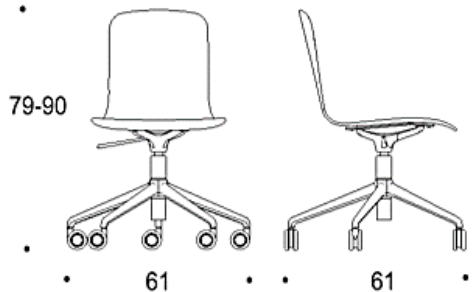

Solid low back

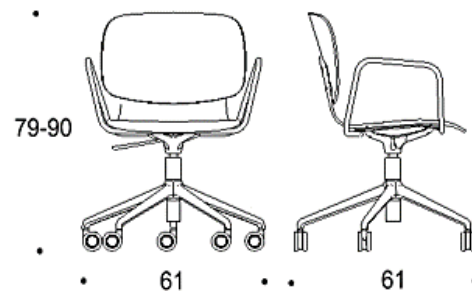

Two-part low back with armrest

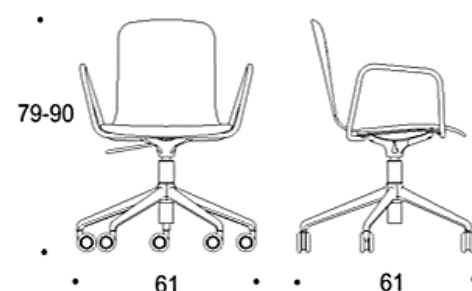

Solid low back with armrest

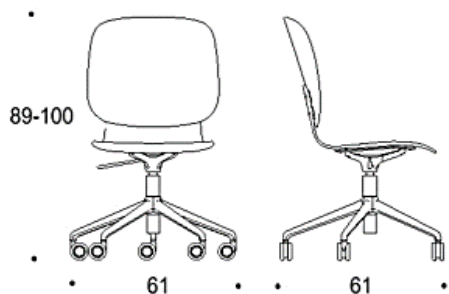

Two-part high back

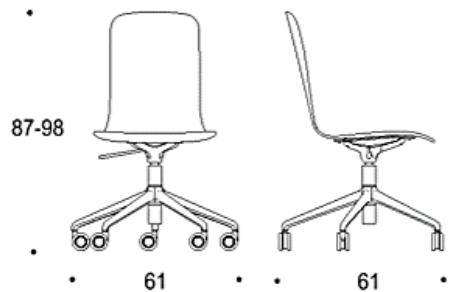

Solid high back

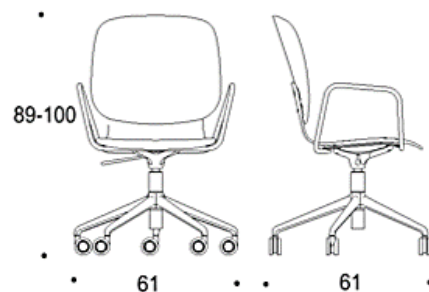

Two-part high back with armrest

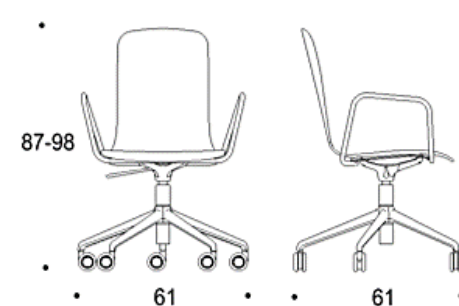

Solid high back with armrest



Tutto

ISKU
Since 1928

Tutto

HEIGHT-ADJUSTABLE CHAIR WITH 5-STAR CROSS-BASE

Design Mikko Laakkonen

Tutto is a beautiful and diverse family of chairs that grows and serves the wide variety of interior design needs. The chair with 5-start cross-base is a good option for working chair or to the meeting rooms.

The Tutto chair and the its designer Mikko Laakkonen received an Honorary Award in Suomi100 Design Competition operationalized by ISKU.

Materials and finishing

The cross-base is powder-coated steel (black, white) or chrome, Equipped with castors or pads. Armrests available.

Seat and backrest option and materials are described in the *Models, Materials and Functions Datasheet*.

Dimensions

Width	580 mm
Depth	580 mm
Seating height	380 – 510 mm (with castors), 350 – 480 mm (with pads)
Height	Depending on the selected back rest and cross-base

The dimensions are specified as per the models on the following datasheet.



Tutto

HEIGHT-ADJUSTABLE CHAIR WITH CROSS-BASE AND CASTORS

Dimensions

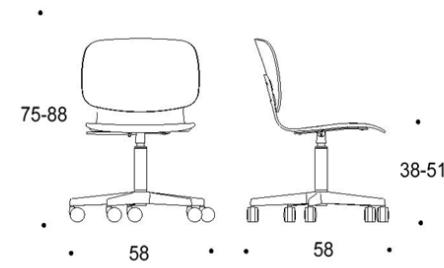

Two-part low back

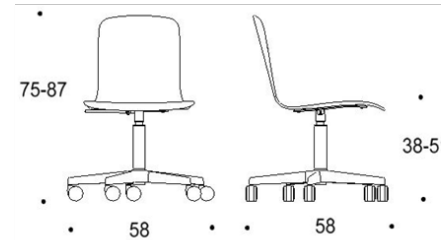

Solid low back

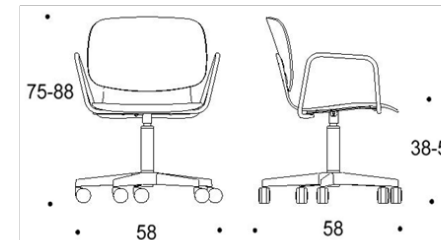

Two-part low back with armrests

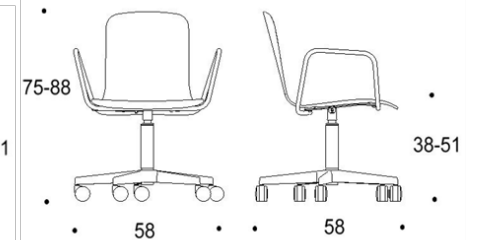

Solid low back with armrests

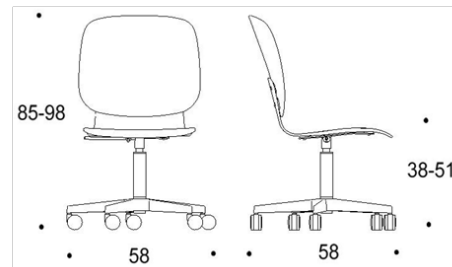

Two-part high back

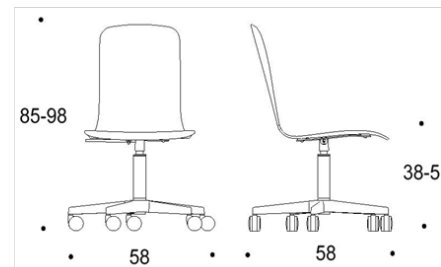

Solid high back

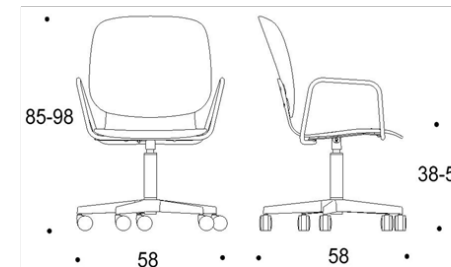

Two-part high back with armrests



Solid high back with armrests

Tutto Meeting

MEETING CHAIR WITH CROSS-BASE

HEIGHT-ADJUSTABLE CROSS-BASE WITH CASTORS | 4-LEG CROSS-BASE WITH PADS

Design Mikko Laakkonen

Tutto is a beautiful and diverse family of chairs that grows and serves the wide variety of interior design needs. The newest member in the Tutto family is the soft and pleasant meeting chair with thicker filling for better sitting comfort. Tutto Meeting is a sturdy yet light chair for working or meeting rooms. The chair is available with two cross-base and backrest options, and with or without armrests. The chair can be upholstered with ISKU standard fabrics with some exceptions.

Antimicrobial option available.

Materials and finishing

Cross-base	Powder-coated steel (black, white, polished aluminum (chrome colored)
Wood	From ISKU standard collection birch, beech, oak and ash / Technical veneers / painted black or white (*wood part visible only in two-part seat)
Upholstery	ISKU standard collection (excluding Blazer, Comfort+, ESD, Europost2, Laminated Step and Maglia)

Dimensions

Width	The dimensions are specified as per the models on the following dimensions datasheet.
Depth	
Height	
Seating height	45 cm or with height adjustable cross base 44-55 cm



Tutto Meeting

Dimensions



4-LEG CROSS-BASE WITH PADS | Seating height 45 cm

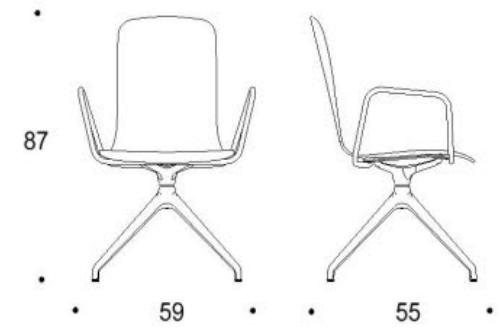
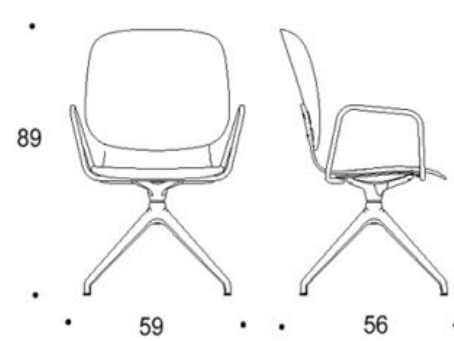
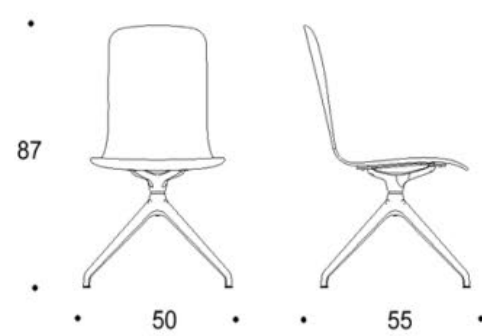
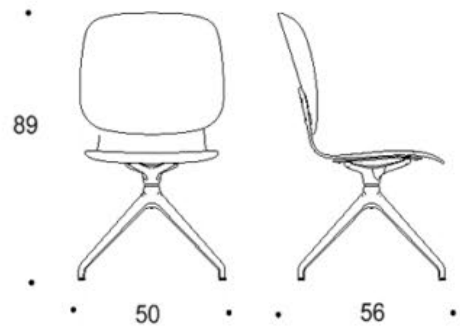

HEIGHT-ADJUSTABLE MEETING CHAIR WITH CROSS-BASE AND CASTORS | Seating height 44-55 cm

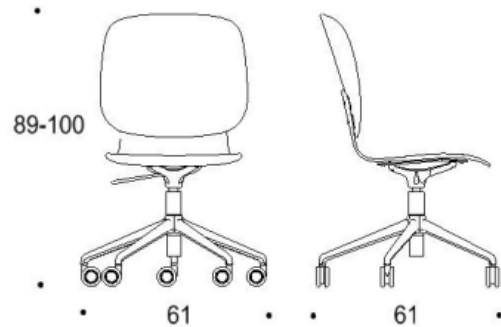

Two-part high back

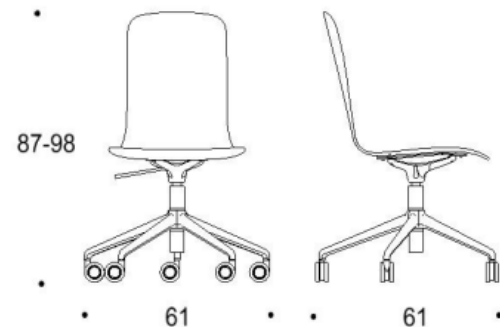

Solid high back

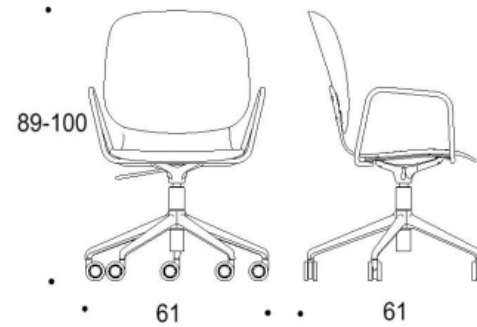

Two-part high back with armrest

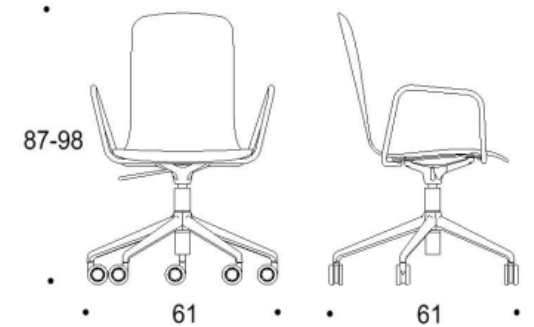

Solid high back with armrest



Tutto Meeting

ISKU
Since 1928



ISKU+

Tutto Meeting

ISKU
Since 1928

Tutto Active

SADDLE CHAIR

Design Mikko Laakkonen

Tutto Active is a saddle chair that helps the user to stay active while working. Tutto Active is responding to the growing trend of saddle chairs. What makes the design of Tutto Active special is the beautifully shaped seat.

Tutto Active is available also in junior size.

Materials and finishing

Base	Powder-coated steel with cross-base (black or white). Five castors.
Seat	Beech, birch, ash and technical veneers. ISKU standard stained colors available. Standard ISKU laminates (300-series). With or without upholstery. ISKU standard fabrics and leathers.

Dimensions

Width	600 mm
Depth	600 mm
Seating height	500 - 750 mm / 390-510 mm





Tutto Active

ISKU
Since 1928