



ISKU

STANDARD TABLE TOPS

TABLE TOP STANDARD

Tops are 26 mm thick furniture board or MDF covers.

Asymmetrical tops are shown left-handed but are also available right-handed.

Beech veneered lids can be stained with ISKU standard stain colors.

Veneered EL and P tops are beveled MDF covers. Lam 215 (white) and lam 230 (light gray) EL and P covers are ABS edged.

Top collection is available laser-edged.

The entire collection can be implemented as an antimicrobial.

Edge options

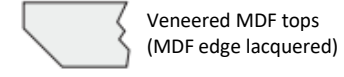

Edge options

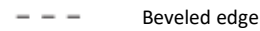
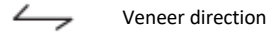
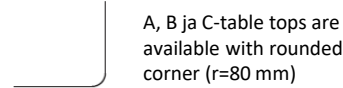
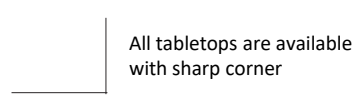

Cast edge (Teamix) available for the following

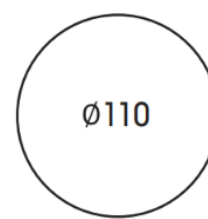
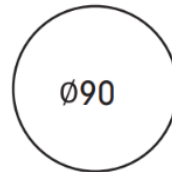
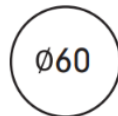
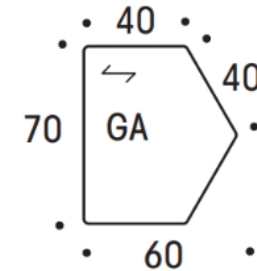
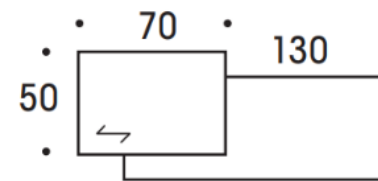
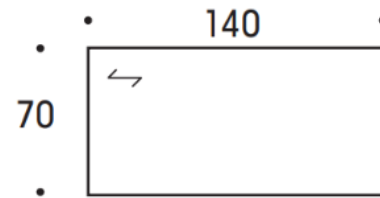

Universal and work desks

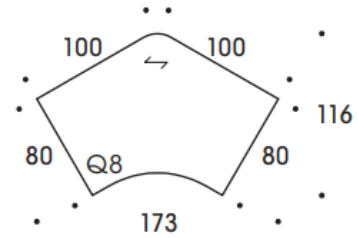
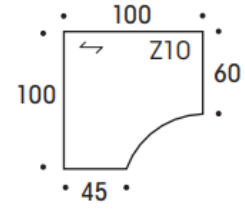
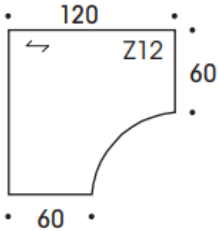
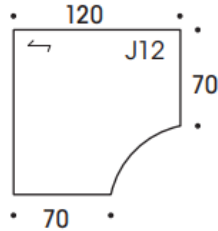
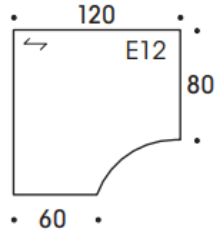
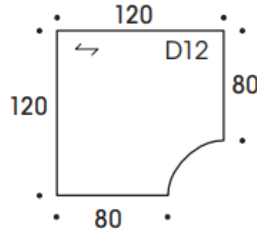
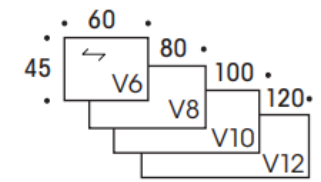
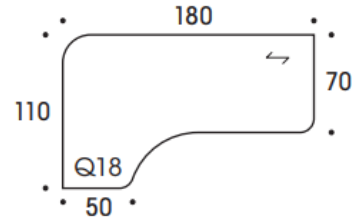
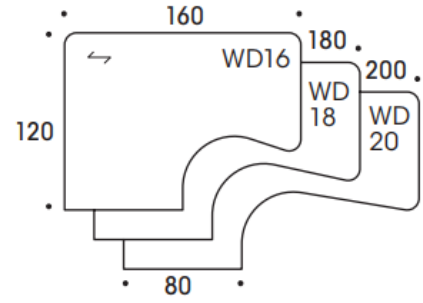
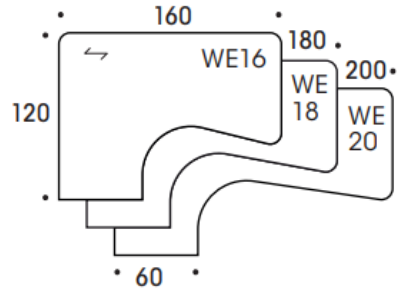
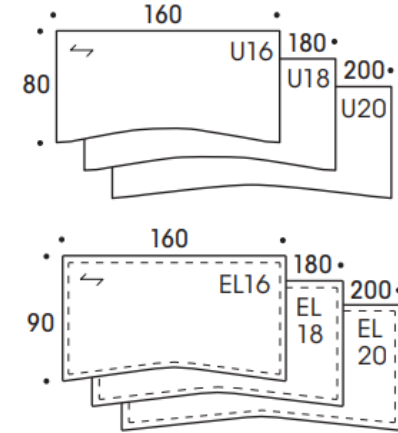
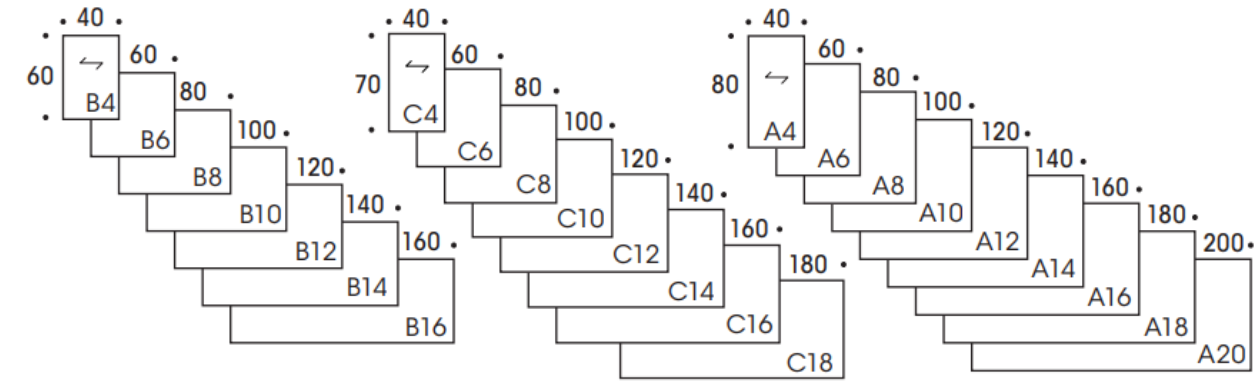

Conference tables

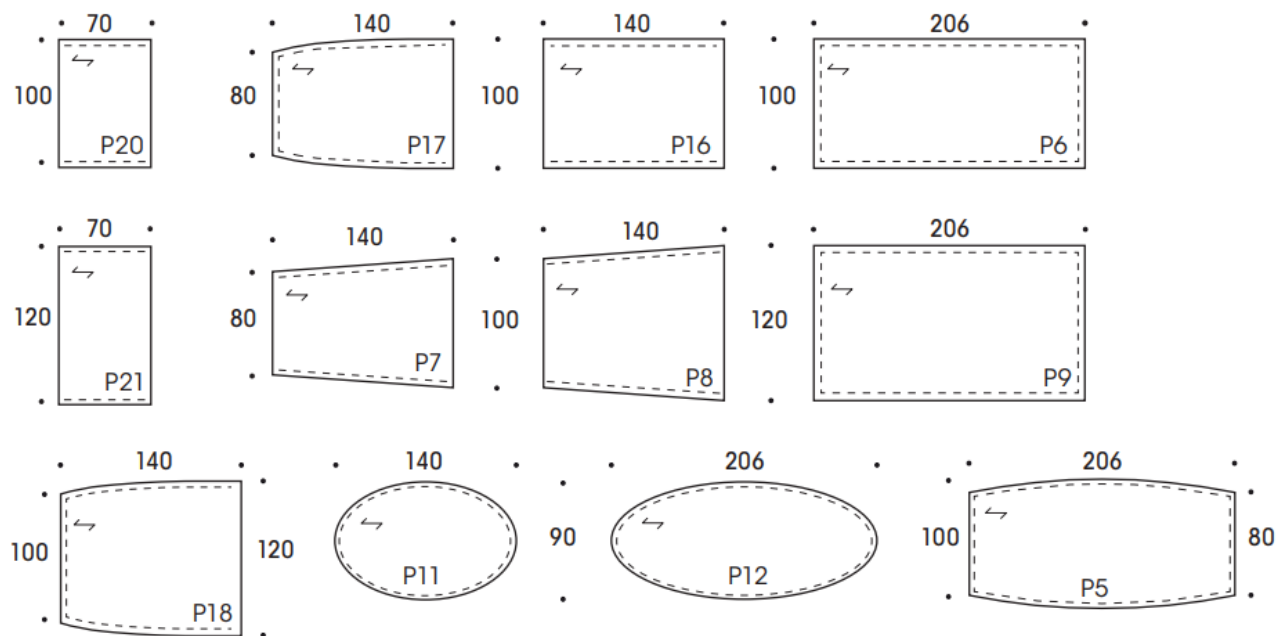

Groupworks tables

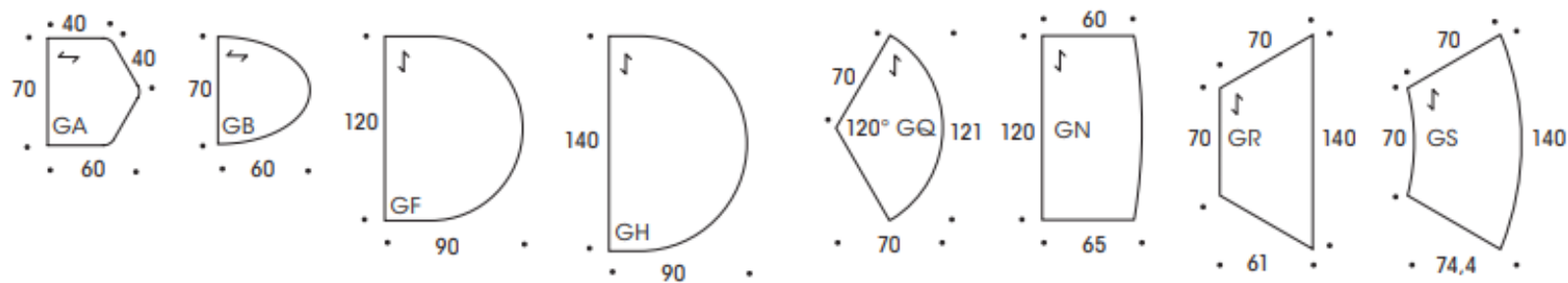

Round and oval tables

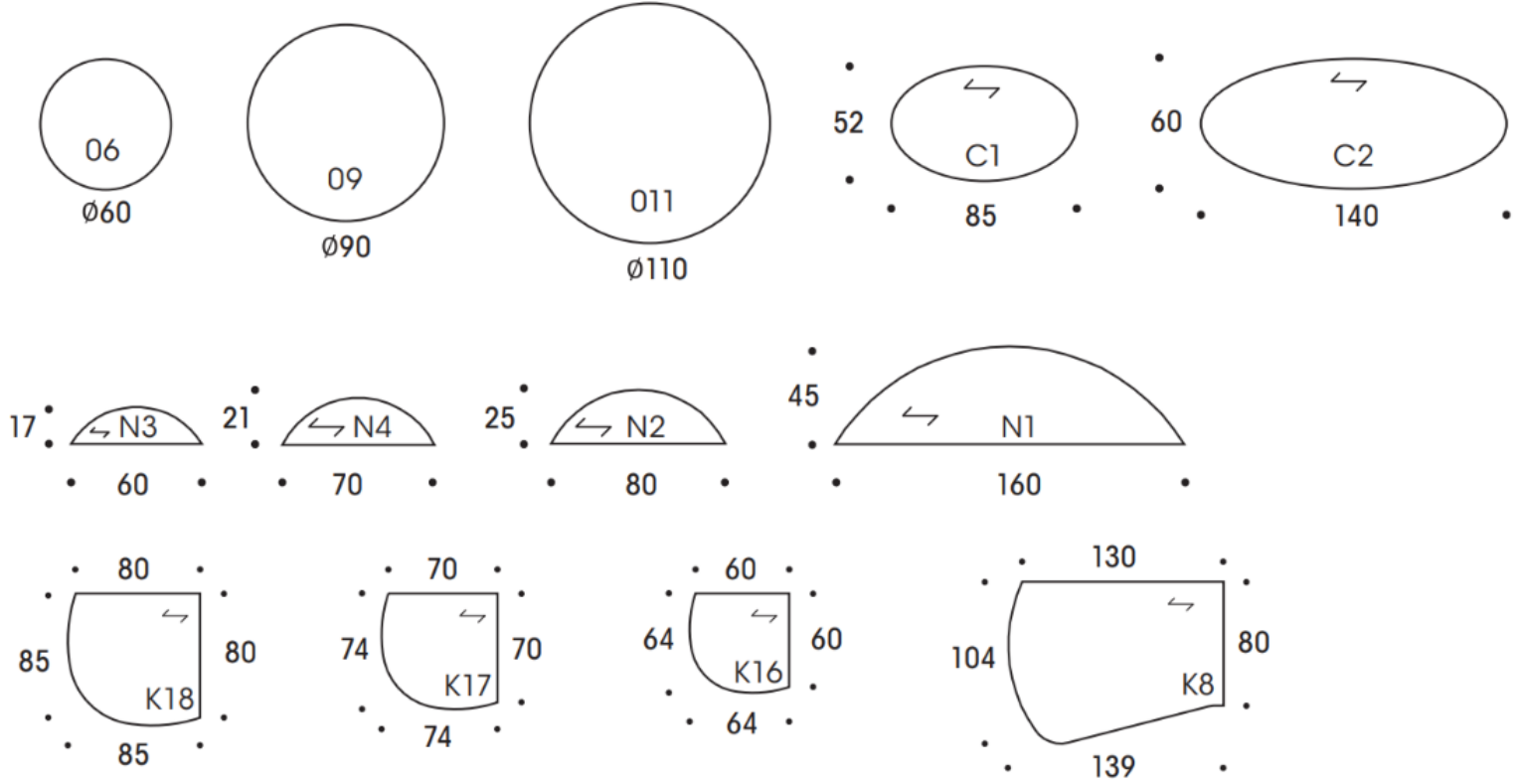

Nook, Kivikko and Solu tables

